

Article number: 201240110

Description: E+G Retaining magnets with smooth stud GN 52.4-ND-10-M4-E  
Neodymium, iron, boron - 80° C, 24N

## Measures

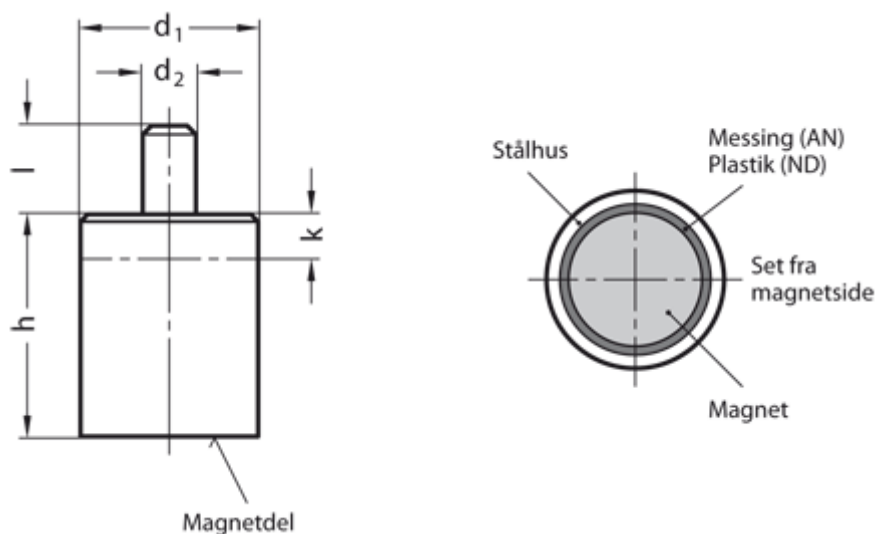

d1 = 10

d2 = 4

h = 20 ±0,2

Holding force N = 24.0

k = 10 mm - Max. dimension the magnet can be shortened

l = 8

Material = ND Neodym, iron, boron, 80°C